

1083/12 - 1083/15 - 1083/16

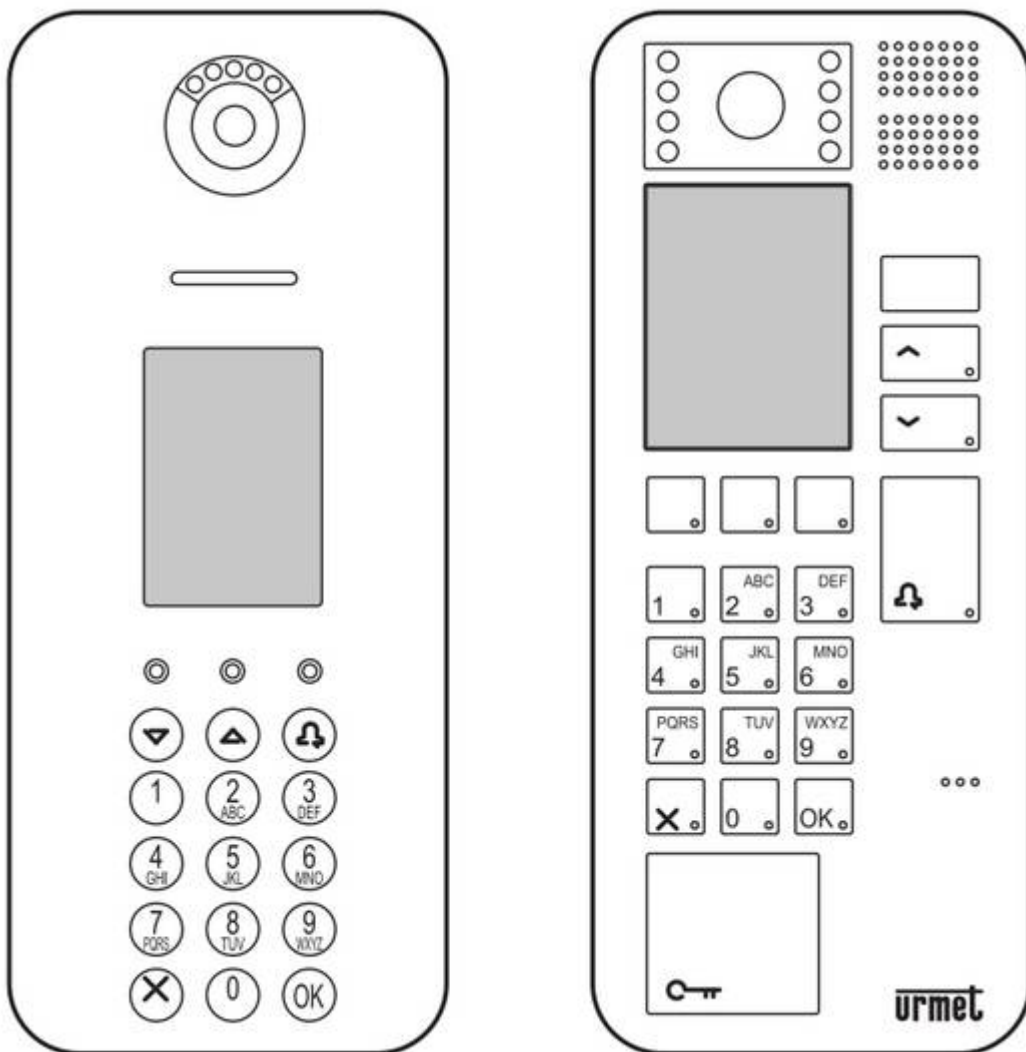

Configuration guide

Contents

Introduction	Page 1
Menu structure	Page 3
Configuration procedure	Page 4
Programming proximity access keys	Page 14
Programming door open codes	Page 15
Appendix	Page 16

Introduction

This programming guide is intended specifically for a particular type of system – **System Type B**

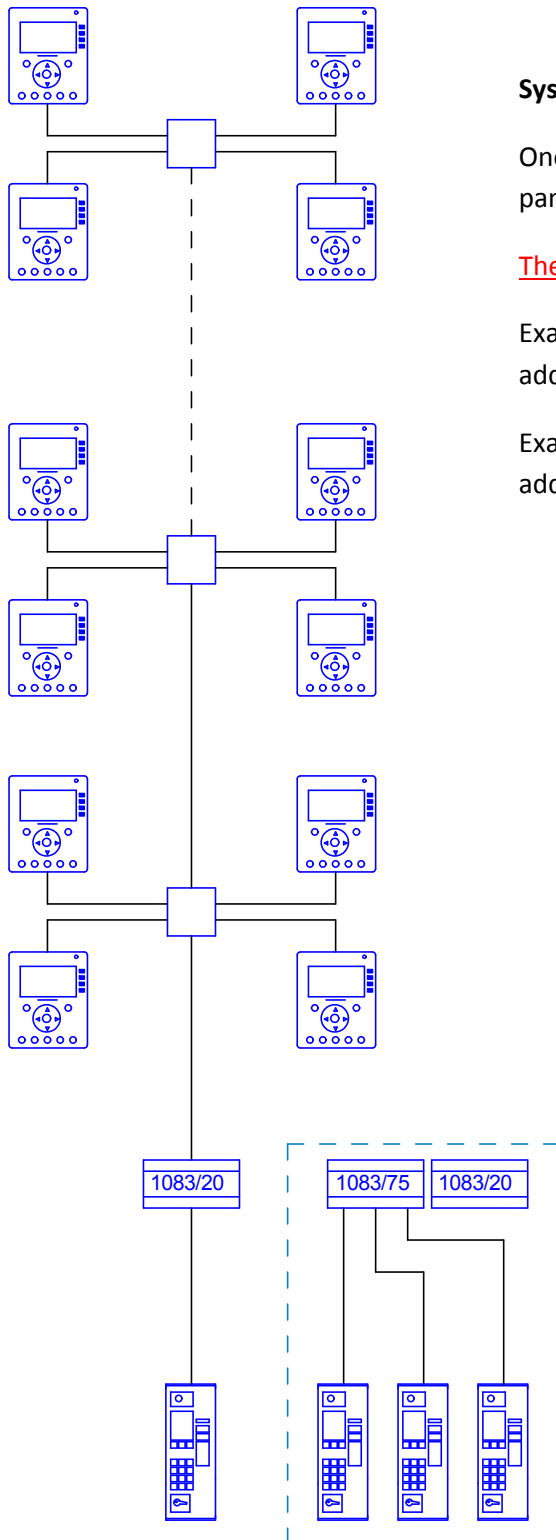

System Type B –

One (or up to a maximum of four) 'Main' entry panels i.e. panels which call all apartments in the system.

The apartment numbers are *not* in the range of 1 to 127.

Example 1 - A block of fifty apartments with postal addresses from 201 to 250

Example 2 - A block of twenty apartments with postal addresses from 451 to 470.

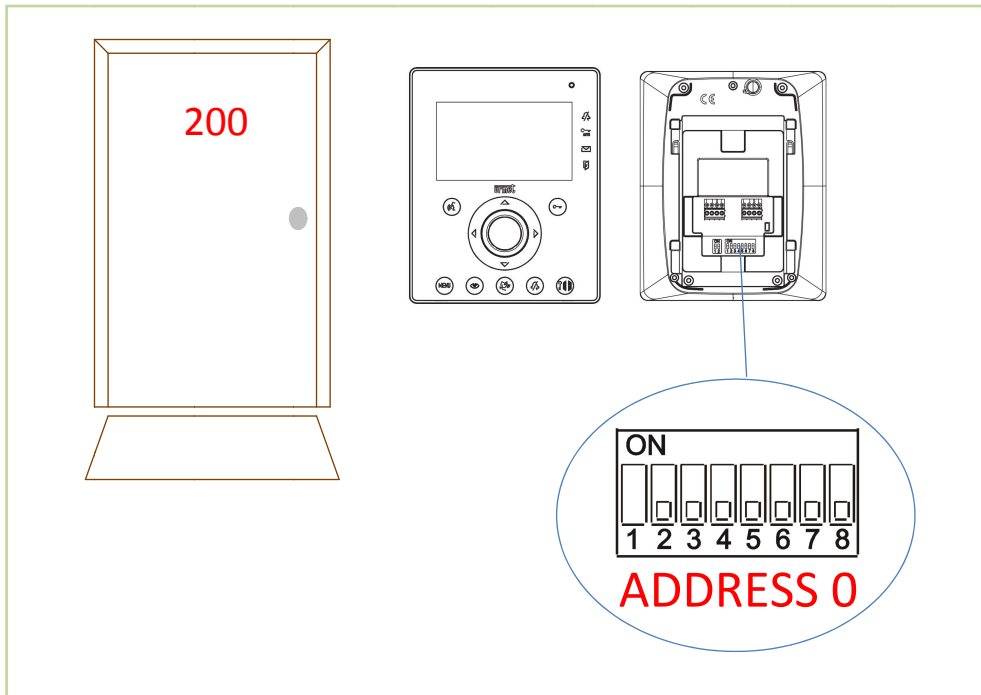

In **System Type B** it is necessary to create an *OFFSET* in the numbering sequence.

The reason is that using monitor DIP switches 2-8 (switch 1 is not used) the largest number that can be made is 127.

So for example the DIP switch setting in apartment 200 could be 0.

The system needs to 'know' that when a visitor dials 200 the monitor or handset with address 0 (postal address 200) must be called.

In this case the *OFFSET* would be 200.

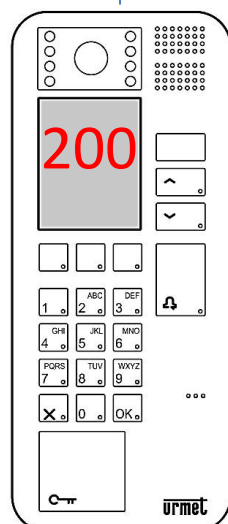

Menu Structure

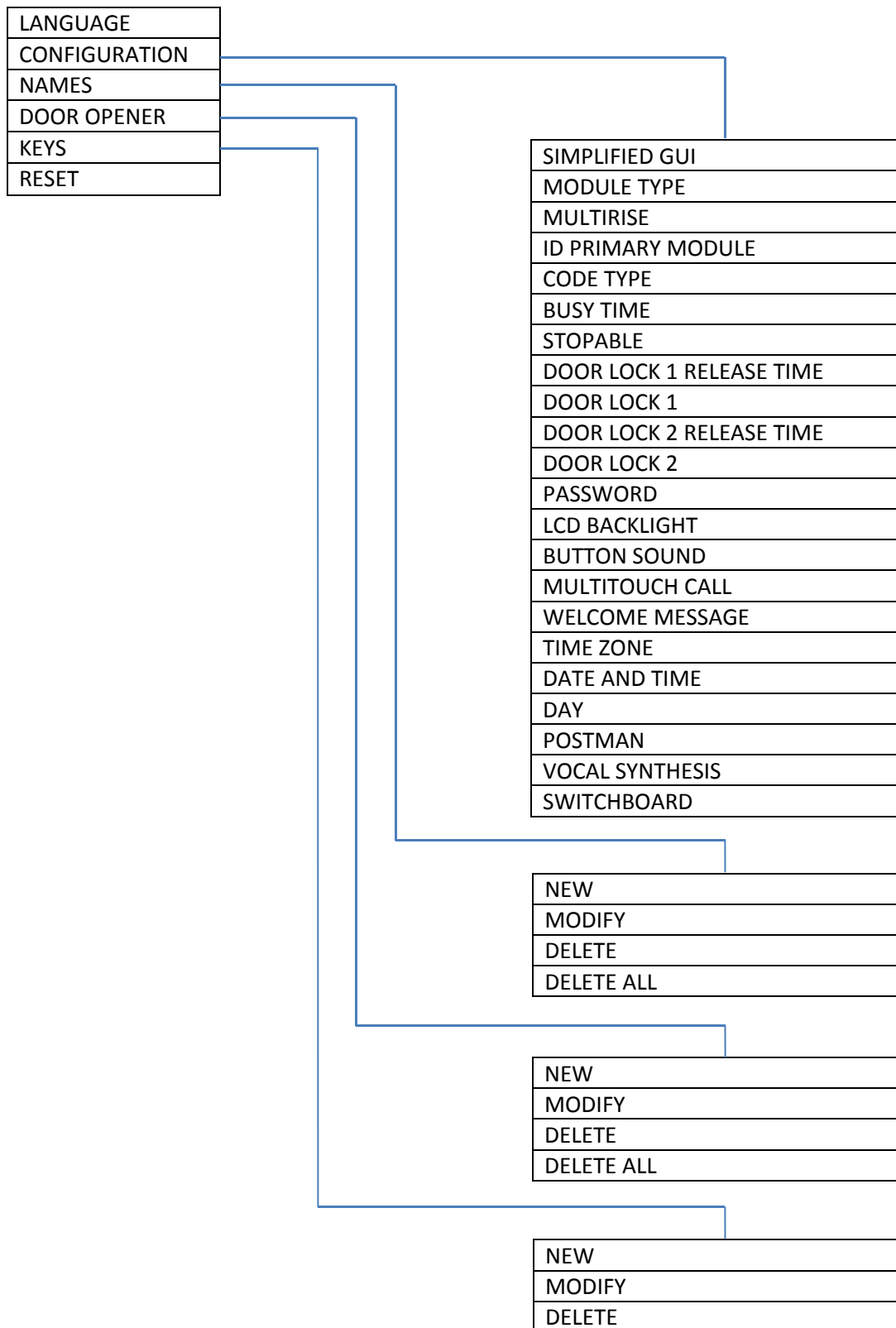

Configuration procedure

When the unit is first powered the screen is as follows –

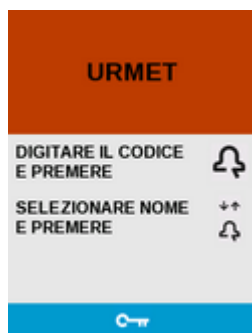

On the entry panel keypad press **99999** and you will see this screen –

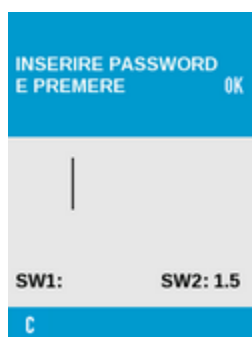

Enter **1000** (the default password) then press



Use the  and  buttons to select

LINGUA and press

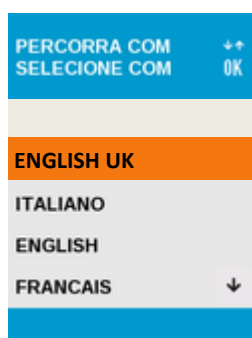

Use the  and  buttons to select

ENGLISH UK and press



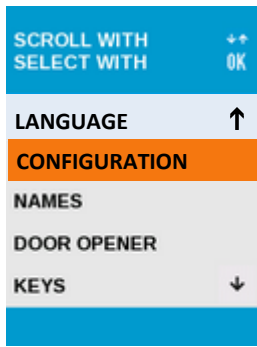

You see this screen –





Press the  button to select **CONFIGURATION** then press .

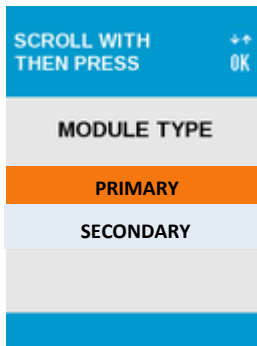

Use the  or  buttons to select **YES** and press .



Use the  or  buttons to select **PRIMARY** and press .

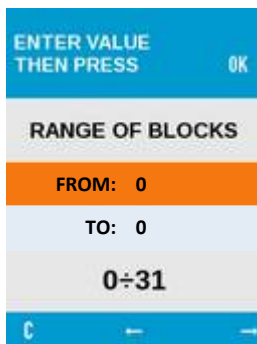

Press .



In a system with only one entry panel the ID is always **0**. In this case just press

In a system with two, three or four panels, each must have a different ID.

The ID of the panel is determined by where it is connected in the system. You must refer to the connection diagram of your system for the ID of each panel.

For example to change the panel ID to **1** just press then press



It is suggested to keep the default setting by pressing



It is suggested to keep the default setting by pressing

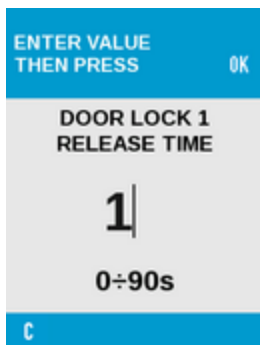

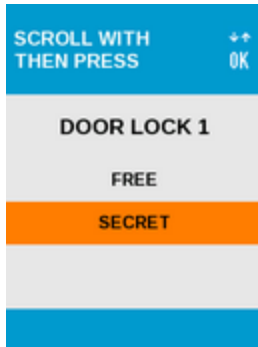

DOOR LOCK 1 RELEASE TIME adjusts the voltage free relay (C NO NC) time and also the solid state lock release output (SE+ SE-) time.

For example for a time of 10 seconds press **1 0**



Choosing **FREE** means that the door can be opened by the monitor or handset at any time without the monitor or handset being called.

Choosing **SECRET** means that the monitor or handset must be called before it can open the door.

Use the  or  buttons to make a selection then press .

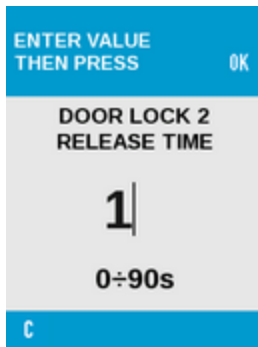

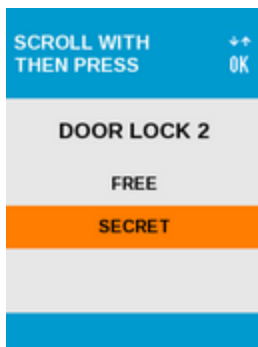

DOOR LOCK 2 RELEASE TIME adjusts the voltage free relay (C NO) time.

For example for a time of 1 second press **1** then press .



Choosing **FREE** means that the gate can be opened by the monitor or handset at any time without the monitor or handset being called.

Choosing **SECRET** means that the monitor or handset must be called before it can open the gate.

Use the  or  buttons to make a selection then press .

For an explanation of the three different lock outputs see the appendix Page 14

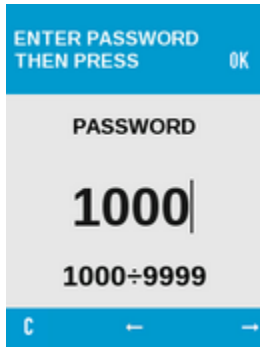



Change the **PASSWORD** if required by pressing the button below **C** to delete the current password -



Enter the new password and press



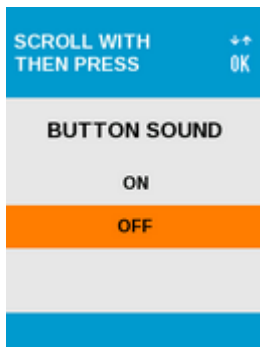

Adjusts the panel display backlight

Use the  or  buttons to make a selection then press .



The entry panel button confirmation beep can be **ON** or **OFF**.

Use the  or  buttons to make a selection then press .



It is possible that when a number of buttons are pressed at the same time, a particular monitor or handset can be called, for example a caretaker's apartment.

If you wish to use this feature enter the apartment address then press .

Otherwise just press .

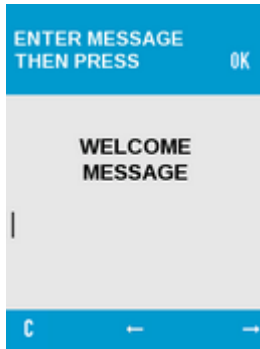



A **WELCOME MESSAGE** can be entered. This is the message which visitors will see when they approach the panel, for example the Block Name. The message can be two lines with each line having a maximum of sixteen characters.

Use the keypad characters to enter the welcome message.



Use  to correct mistakes.





Use  and  to move from the first to the second line.



Press  when finished



To modify the TIME ZONE select **YES** then press . Choose **EUROPE** as the **CONTINENT** and press . Choose **BRITAIN (UK)** for the **COUNTRY** and press .



Modify the **TIME AND DATE** as required





Use  to correct mistakes.



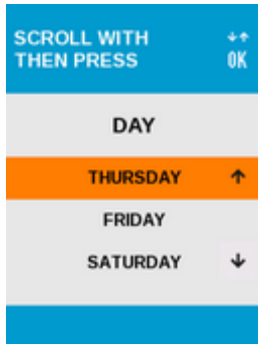

Use  and  to move from the date to the time





Use the  or  buttons to select the **DAY** then press .

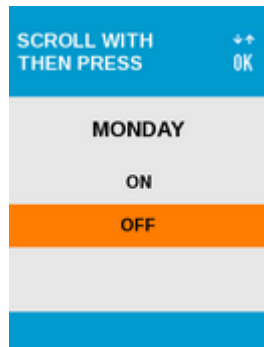

If you are not using the **POSTMAN** (TRADES) function then select **OFF** and press .

To use the **POSTMAN** function choose **ON** then press .



Choose whether the **POSTMAN** function will work on **MONDAY** by selecting **ON** or **OFF** then press .





Enter the **FROM** time. Press  to move to the **TO** time.

Enter the **TO** time and press .

Repeat for the remaining days



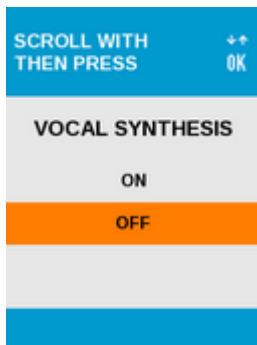

The **POSTMAN ICON** which appears on the display can be **T** or **P**

Use the  or  buttons to select **T** or **P** then press 



The **VOCAL SYNTHESIS** (entry panel spoken instructions for example "*Door open*") can be switched **ON** or **OFF**



Use the  or  buttons to select **ON** or **OFF** then press 





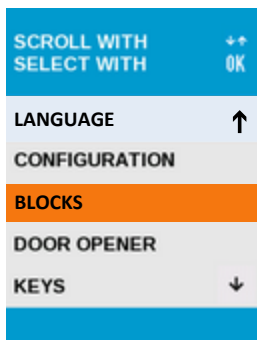

If there is a concierge **SWITCHBOARD** select **ON** and press 

Otherwise select **OFF** and press 

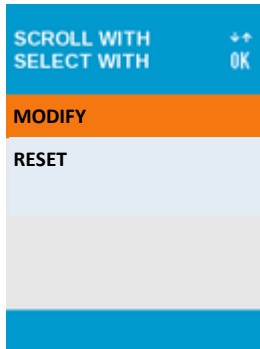

Use the  or  buttons to select **BLOCKS** then press 



Use the  or  buttons to select **MODIFY** then press .

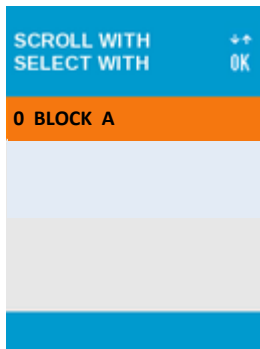

Press .

Enter a name for the block (maximum 12 characters).

If no block name is required it is possible to just enter a space using the **0** button.

For longer block names it is possible to combine the block name with the welcome message.



Use the keypad characters to enter the block name if required.



Use  to correct mistakes.

Press  when finished



Press  

Enter the **OFFSET** number.

See the next page for examples.

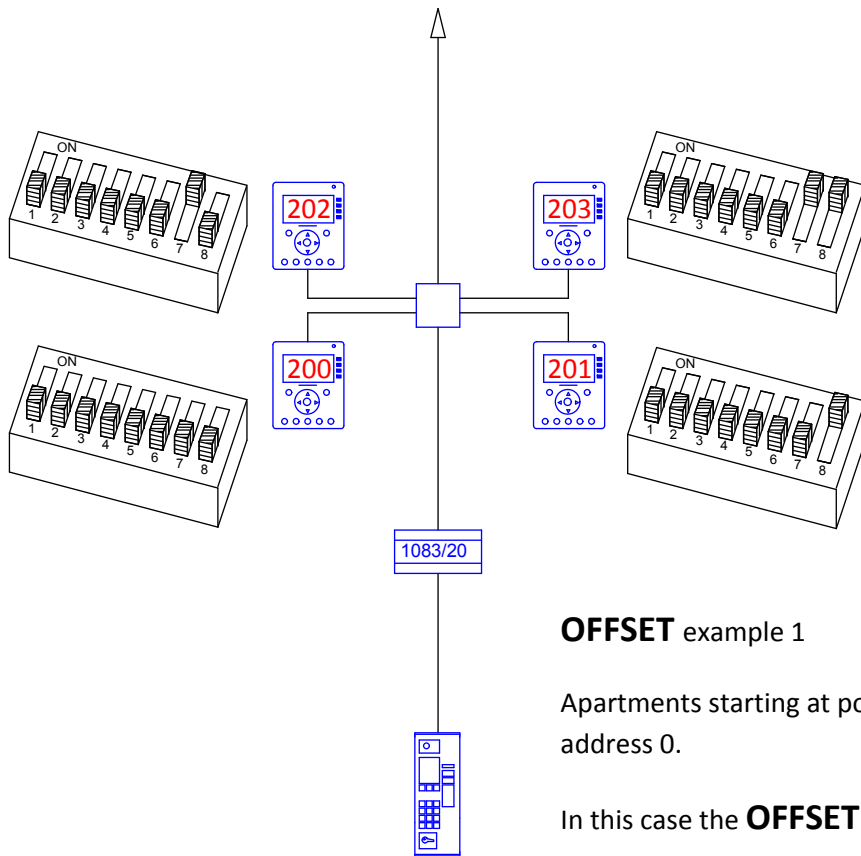

OFFSET example 1

Apartments starting at postal address 200 and starting at binary address 0.

In this case the **OFFSET** would be 200

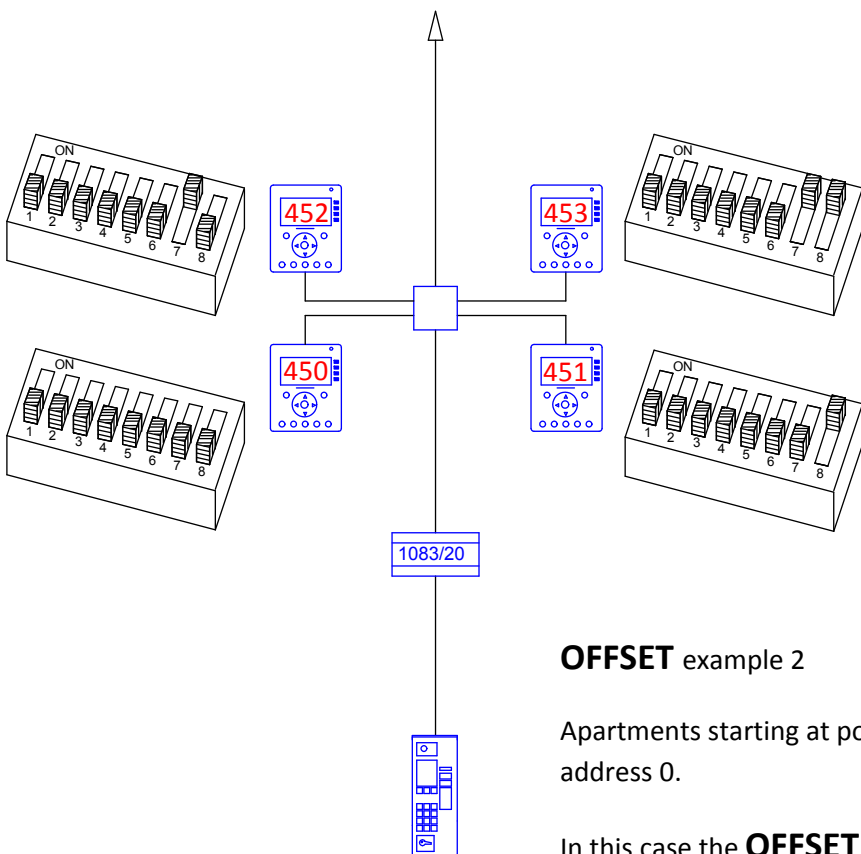

OFFSET example 2

Apartments starting at postal address 450 and starting at binary address 0.

In this case the **OFFSET** would be 450



Programming proximity keys

On the entry panel keypad press **99999** and you will see this screen –



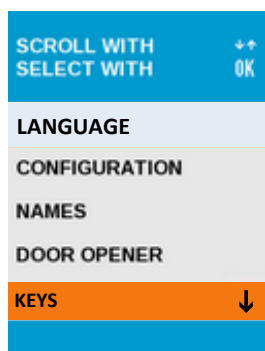

Enter **1000** (the default password) then press

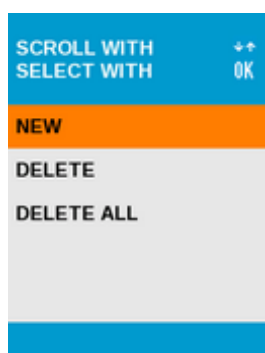

Use the  and  buttons to select **KEYS** and press



Use the  and  buttons to select **NEW** and press

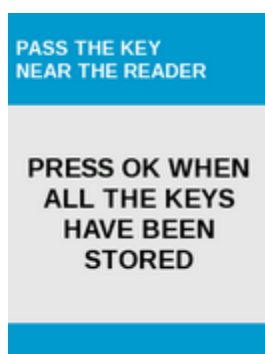

Now hold a key to the entry panel reader .

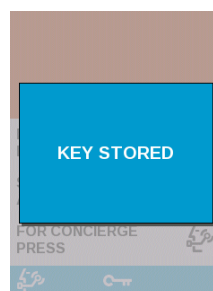

You hear a beep and briefly see

Repeat until all keys have been stored then press



Repeatedly press  to exit from the programming menus

Programming door open codes

On the entry panel keypad press **9999** and you will see this screen –



Enter **1000** (the default password) then press

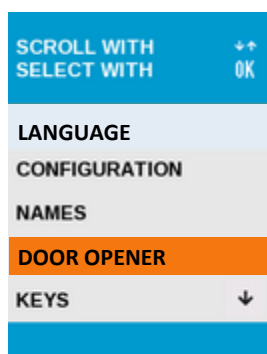

Use the



and



buttons to select **DOOR OPENER** and press

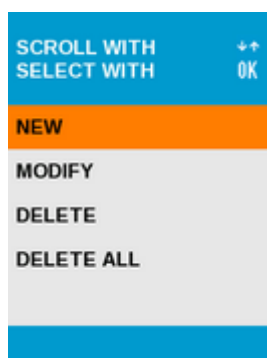

Use the



and



buttons to select **NEW** and press

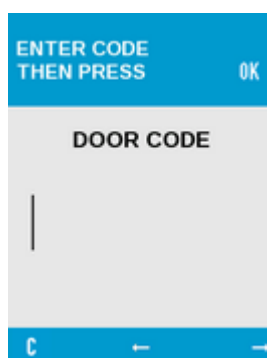

Enter the code and press



Note – The code must be four digits between 0001 and 9999

Repeatedly press



to exit from the programming menus

Appendix

1083/15 & 1083/16 outputs

There are three outputs from the 1083/15 & 1083/16 for controlling electric releases, maglocks automatic doors and gates etc.

S+ S-

This output can be connected directly to a fail *secure* (locked) release with a maximum consumption of 15VA.

The output is triggered by pressing the  button on the monitor or handset.

The time is adjusted using the **DOOR LOCK 1 RELEASE TIME**

C NO NC

Voltage free relay contact used to control fail *safe* releases or maglocks. Can also be used to trigger automatic gates and doors. Rated at 30V AC/DC @ 3.5A

The output is triggered by pressing the  button on the monitor or handset.

The time is adjusted using the **DOOR LOCK 1 RELEASE TIME**

SE2

Normally open voltage free contact used to trigger automatic gates and doors. Rated at 30V AC/DC @ 200mA

The output is triggered by pressing the  button on an Aiko monitor or the  button on a Signo monitor or handset.

The time is adjusted using the **DOOR LOCK 2 RELEASE TIME**

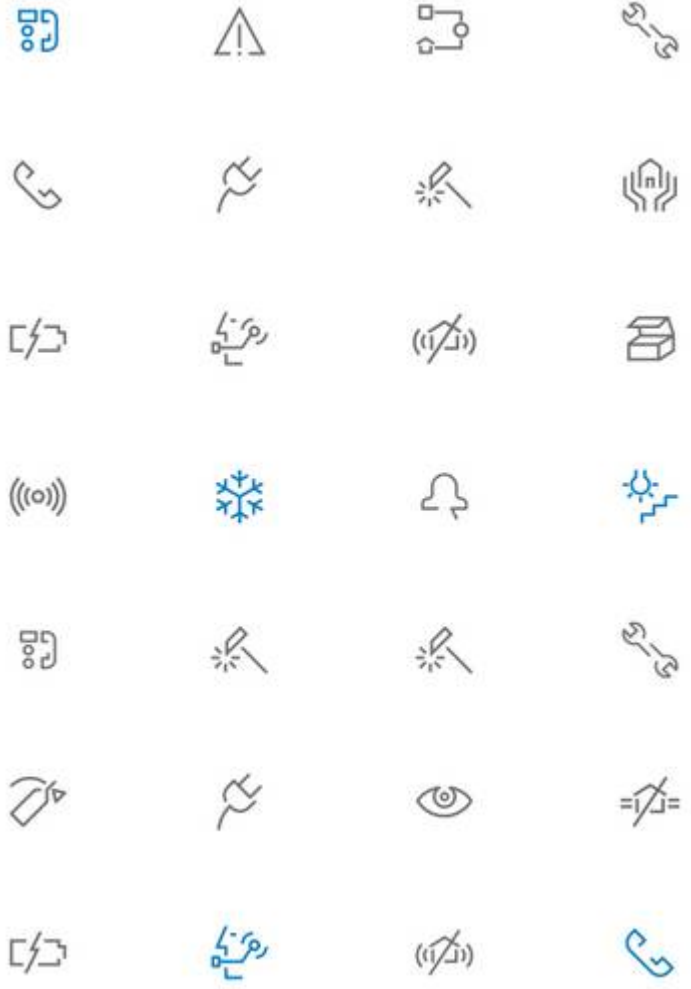

**URMET COMMUNICATION
AND SECURITY UK LTD**

Urban Hive, Skyline 120,
Avenue West, Great Notley,
Essex. CM77 7AA

Tel 01376 556010
Fax 01376 567874
www.urmet.co.uk
sales@urmet.co.uk